



FEATURES

- PLASTIC PACKAGE HAS UNDERWRITERS LABORATORY FLAMMABILITY CLASSIFICATION 94V-0
- ULTRA FAST RECOVERY TIMES FOR HIGH EFFICIENCY
- LOW FORWARD VOLTAGE, HIGH CURRENT CAPABILITY
- LOW LEAKAGE
- HIGH SURGE CAPABILITY
- HIGH TEMPERATURE SOLDERING GUARANTEED:
260°C 0.375" (9.5mm) LEAD LENGTHS FOR 10 SECONDS AT 5 LBS.(2.3KG)TENSION

Mechanical Data

- CASE: MOLDED PLASTIC, DO41, DIMENSIONS IN INCHES AND (MILLIMETERS)
- TERMINALS: AXIAL LEADS SOLDERABLE PER MIL-STD-202, METHOD 208
- POLARITY: COLOR BAND DENOTES CATHODE END
- MOUNTING POSITION: ANY
- WEIGHT: 0.34 GRAMS

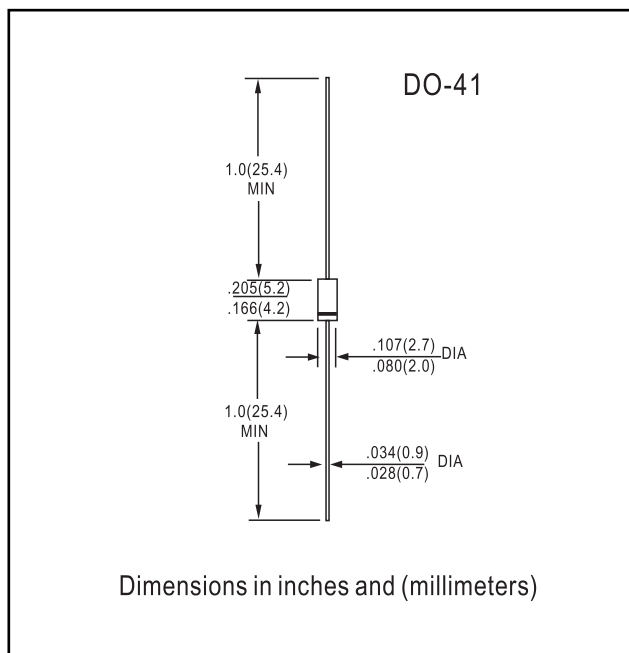

MAXIMUM RATINGS AND ELECTRICAL CHARACTERISTICS

Maximum Ratings

		FUF 4001	FUF 4002	FUF 4003	FUF 4004	FUF 4005	FUF 4006	FUF 4007
V_{RRM}	Peak Recurrent reverse voltage (V)	50	100	200	400	600	800	1000
V_{RMS}	Maximum RMS voltage	35	70	140	280	420	560	700
V_{DC}	Maximum DC blocking voltage	50	100	200	400	600	800	1000
$I_{F(AV)}$	Forward current at $T_{amb} = 55^{\circ}C$	1 A						
I_{FRM}	Recurrent peak forward surge current	10 A						
I_{FSM}	8.3 ms. peak forward surge current (Jedec Method)	30 A						
t_{rr}	Max. reverse recovery time from $I_F = 0.5 A ; I_R = 1 A ; I_{RR} = 0.25 A$	50 ns				75 ns		
C_j	Typical Junction Capacitance at 1 MHz and reverse voltage of $4V_{DC}$	15 pF						
T_j	Operating temperature range	- 65 to + 150 °C						
T_{stg}	Storage temperature range	- 65 to + 150 °C						
E_{RSM}	Maximum non repetitive peak reverse avalanche energy. $I_R = 0.5A ; T_j = 25^{\circ}C$	20 mJ						

Electrical Characteristics at $T_{amb} = 25^{\circ}C$

V_F	Max. forward voltage drop at $I_F = 1 A$	1.3 V	1.7 V
I_R	Max. reverse current at V_{RRM} at $25^{\circ}C$	5 μA	
R_{thj-a}	Max. thermal resistance (l = 10 mm.)	50 °C/W	



RATINGS AND CHARACTERISTIC CURVES FUF4001 THRU FUF4007

FIG. 1-TEST CIRCUIT DIAGRAM AND REVERSE RECOVERY TIME CHARACTERISTIC

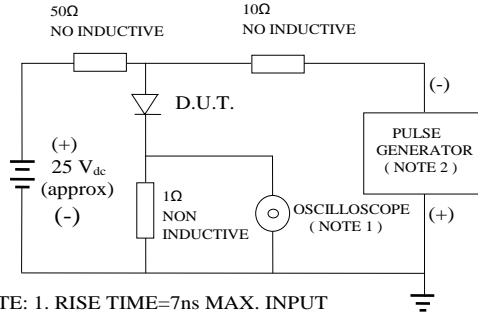

NOTE: 1. RISE TIME=7ns MAX. INPUT IMPEDANCE=1 MOhms 22PF 2. RISE TIME =10ns MAX. SOURCE IMPEDANCE=50 OHMS

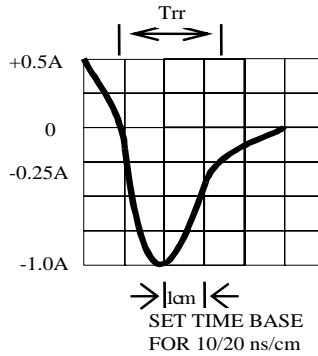

FIG. 2-TYPICAL FORWARD CURRENT DERATING CURVE

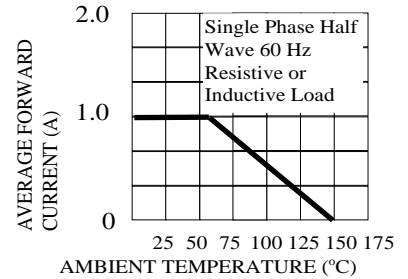

FIG. 3-TYPICAL REVERSE CHARACTERISTICS

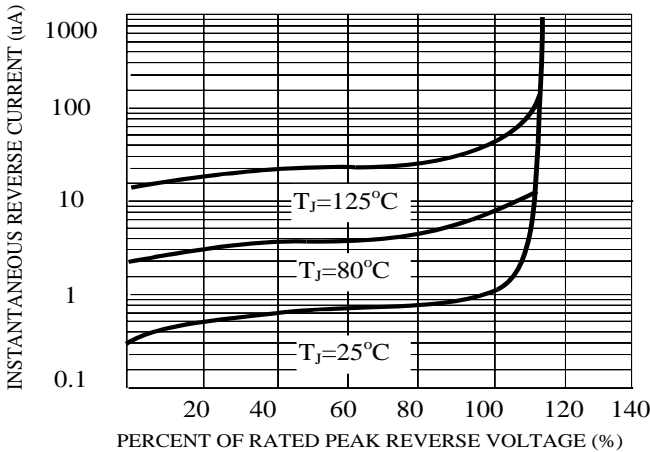

FIG. 4-TYPICAL INSTANTANEOUS FORWARD CHARACTERISTICS

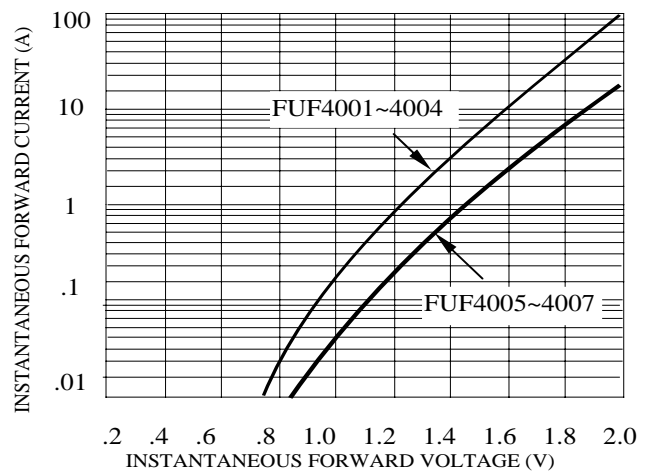

FIG. 5-MAXIMUN NON-REPETITIVE FORWARD SURGE CURRENT

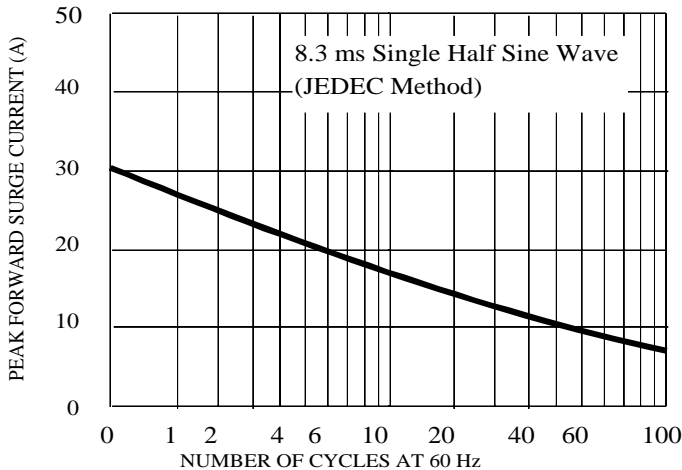

FIG. 6-TYPICAL JUNCTION CAPACITANCE

